

**260329**  
**422212**  
**423212**  
**424212**  
**426162**  
**426200**  
**428952**  
**448000**  
**42008010**  
**42060310**  
**42072110**  
**42272110**  
**42472110**  
**MASW34935**  
**MASW35156**  
**MASW35330**  
**MASW36304**  
**MASW37573**  
**MASW39077**  
**MASW39775**  
**MASW54091**  
**MASW69472**

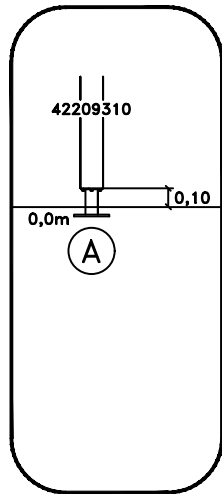

**OM**  
**Above Ground**

8049050  
8049079  
8049083

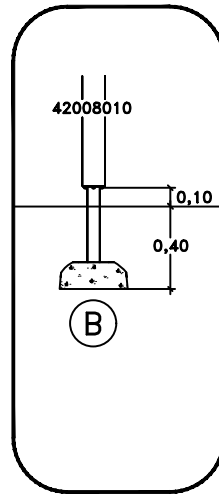

**SF**  
**Sunken Foundation**

8048391  
8049078  
8049082

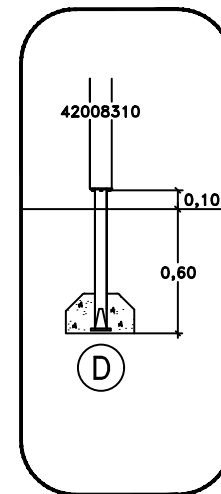

**CC**  
**Cast In Place**

8049062  
8049080  
8049084

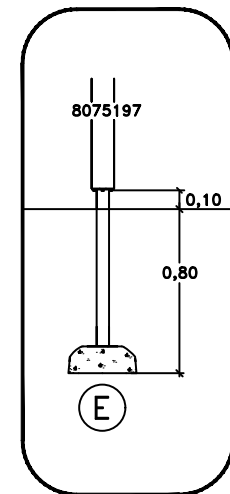

**BM**  
**Loosefill**

8049070  
8049081  
8049085

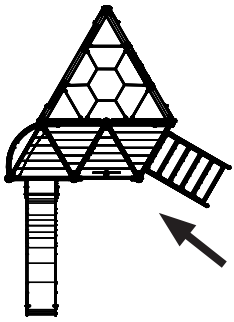

426162  
x4

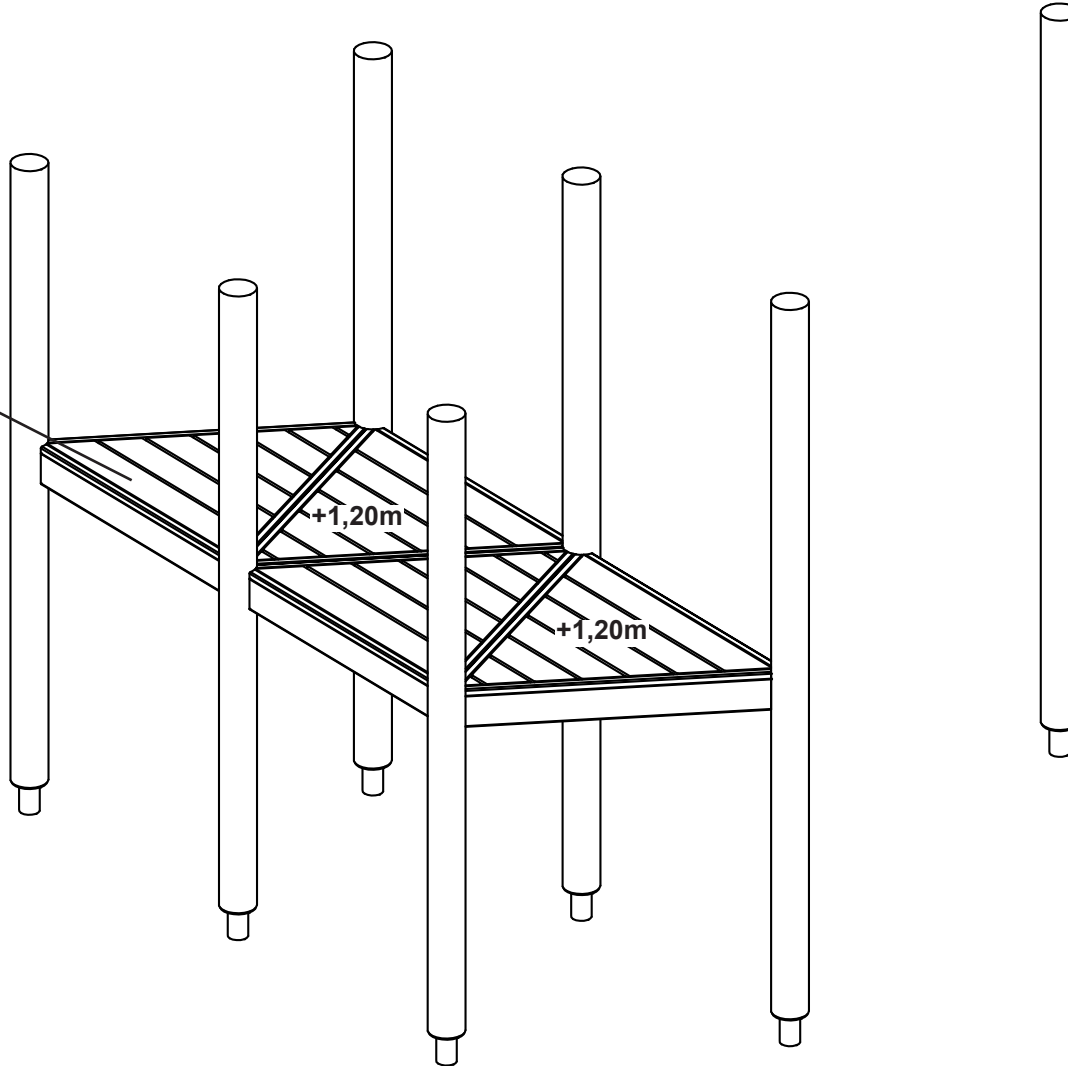

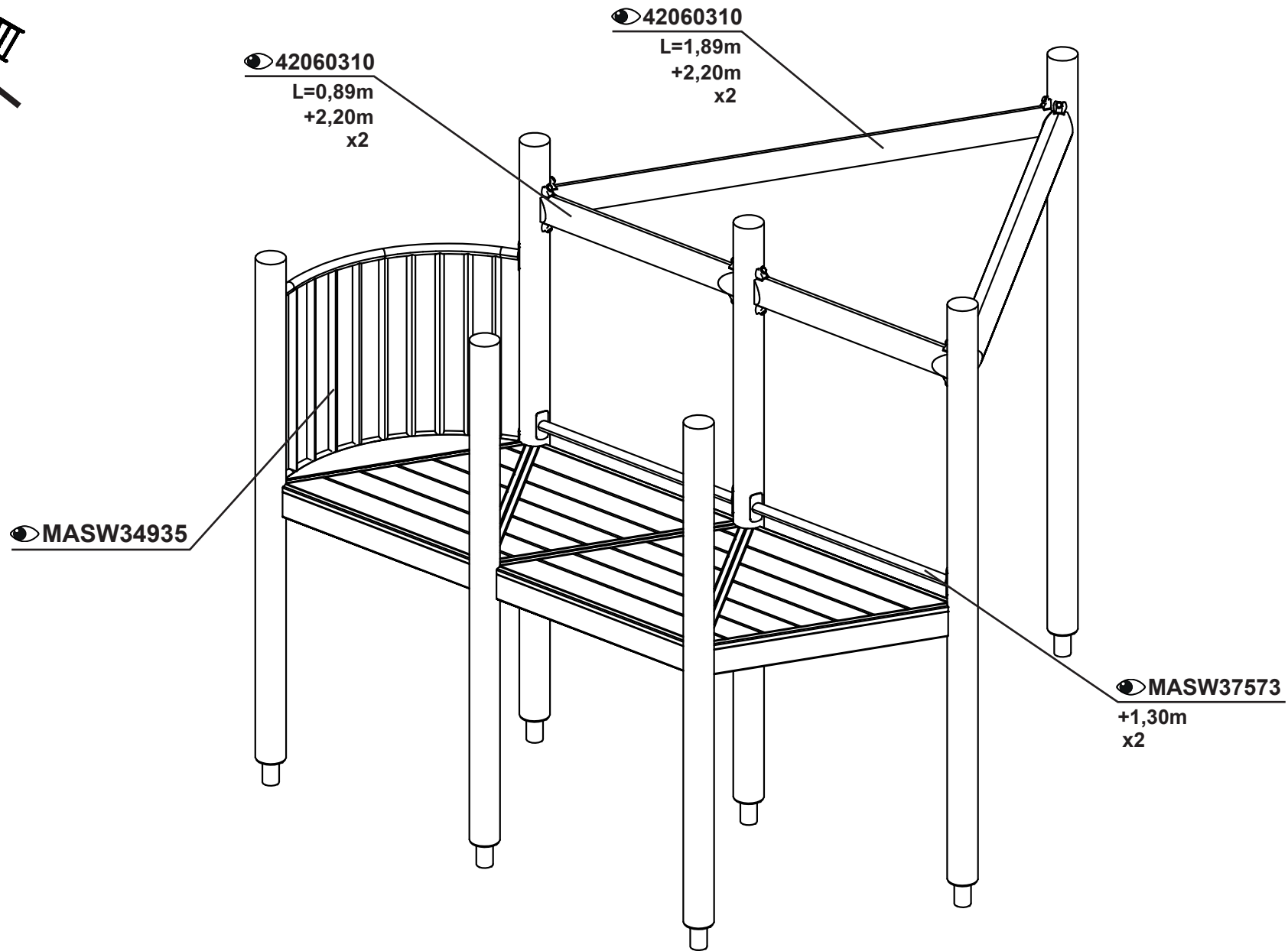
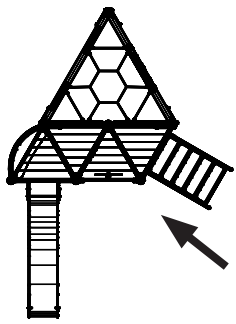

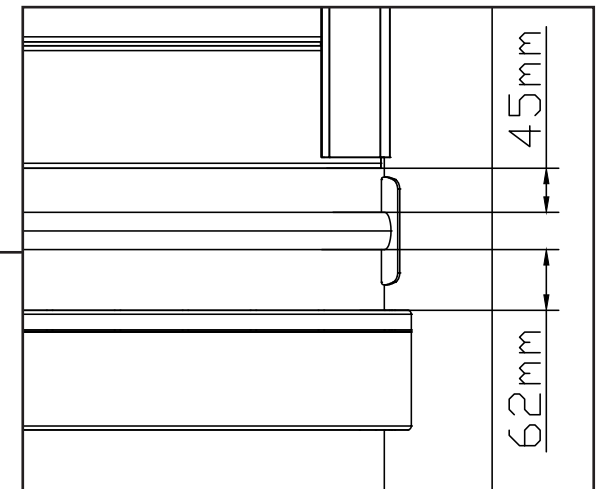
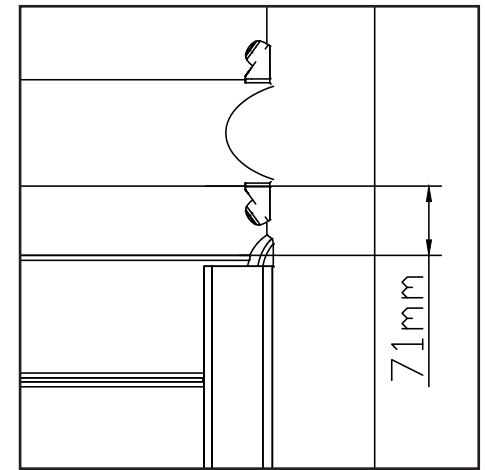
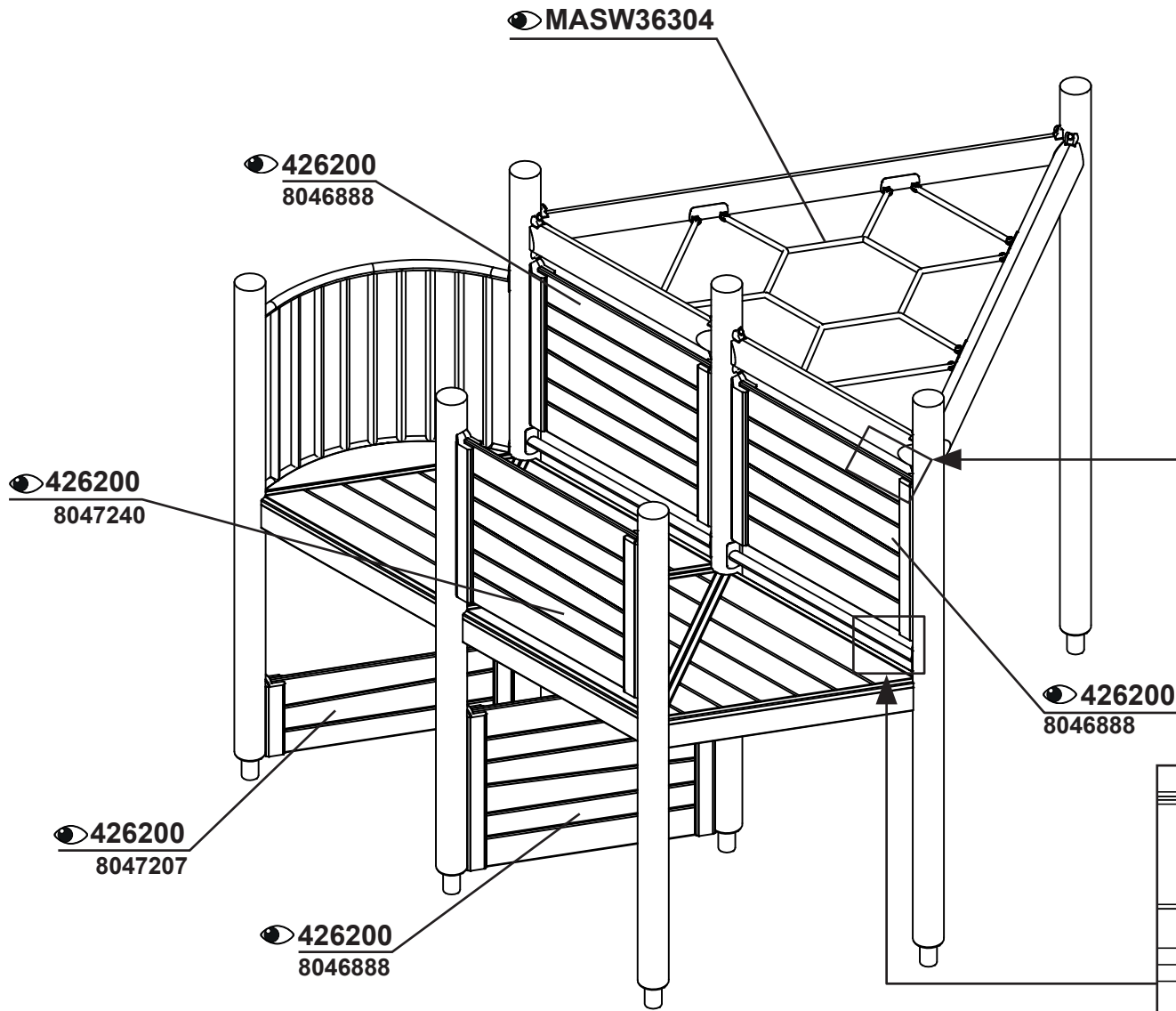
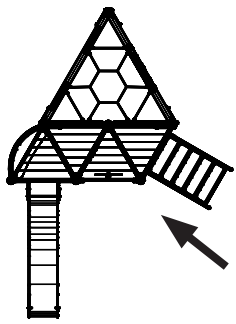

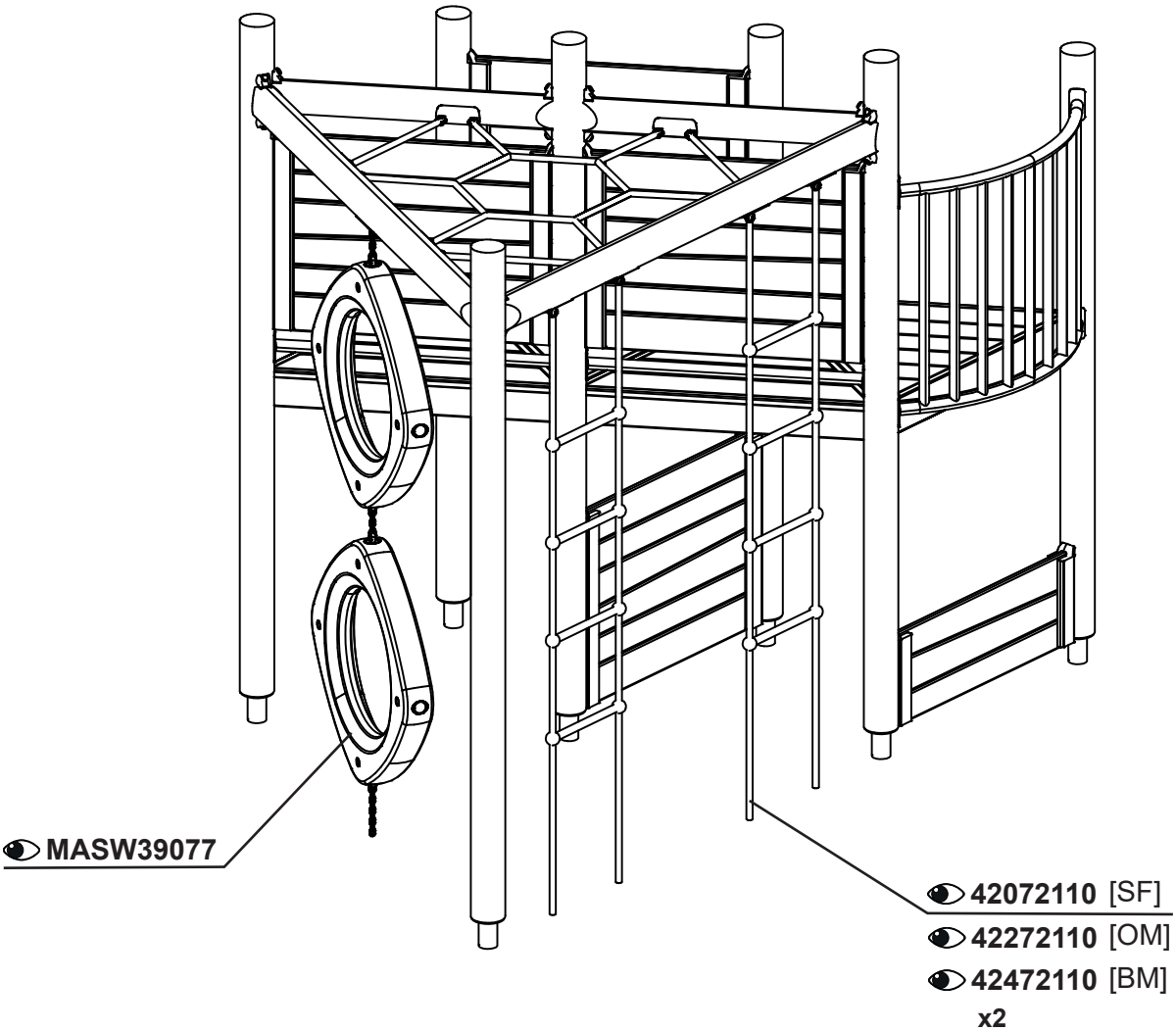
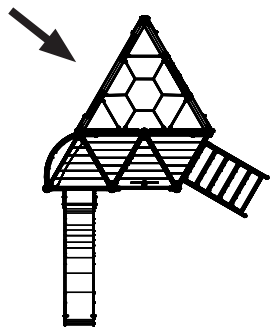



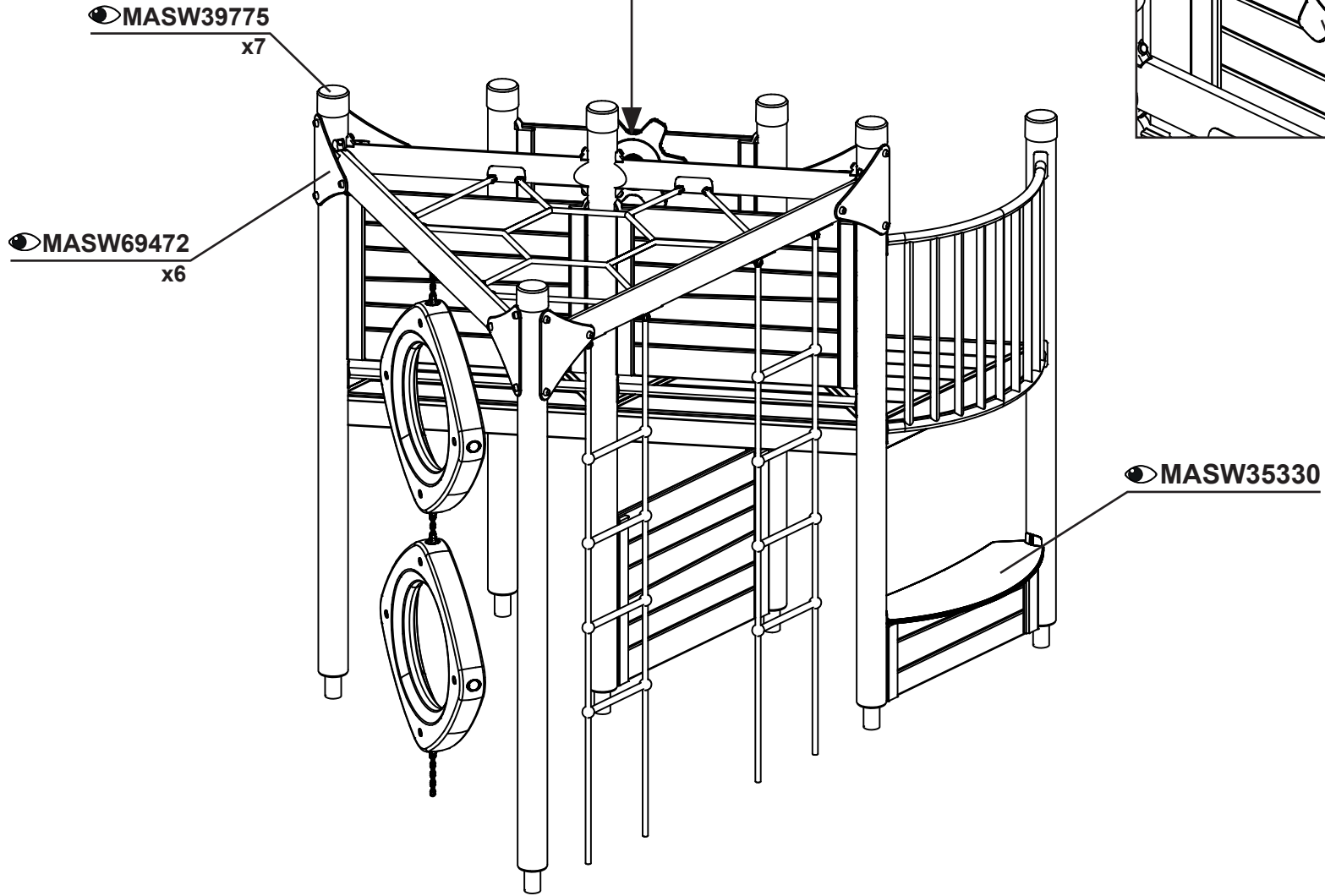
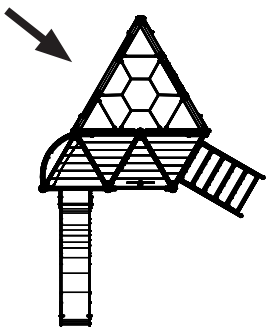

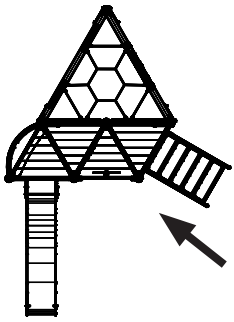

HAGS  
260329

- 423212 [SF]
- 422212 [OM]
- 424212 [BM]

428952

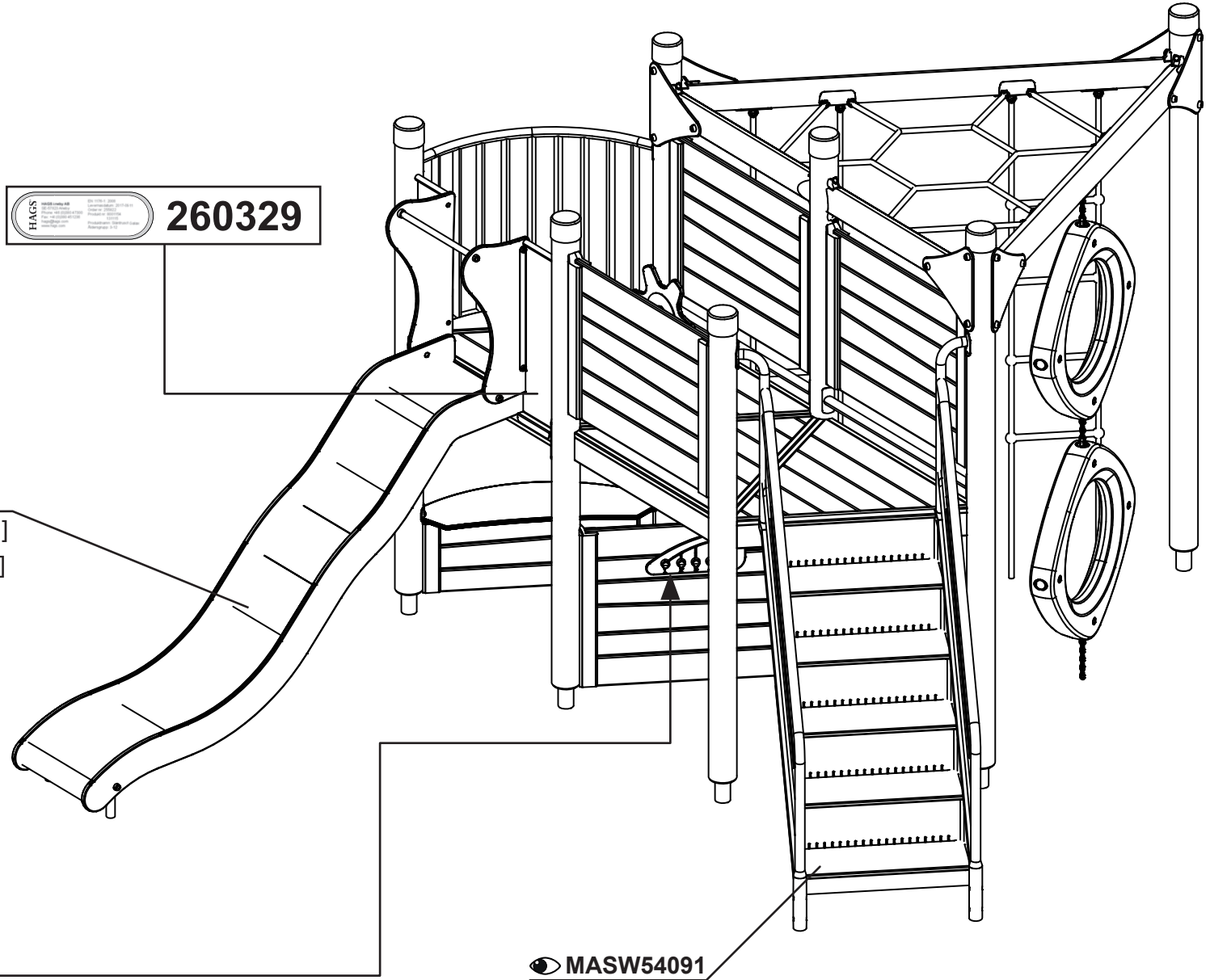
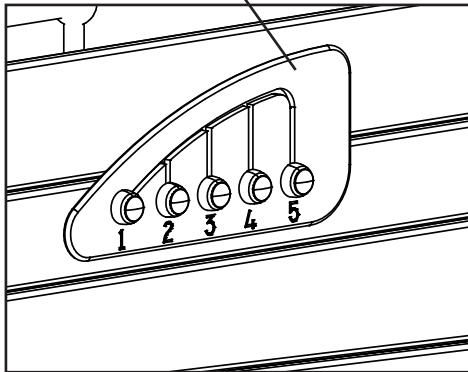

MASW54091